



**BENNINGER**

# EVOLUTION

for safety on the road.  
They all trust your tires.

**Tire Cord**  
Treatment Lines and Technology

# Content

<b>Treatment parts</b>	<b>Devices, systems</b>	<b>Pages</b>
Benninger Zell in a few words	A division of the Benninger AG, Switzerland	3
In Focus: Customer's Benefit	Benninger seeks joint success	4
Tire Cord Treating Lines - At a glance	Flexibility for highest demands	6
Thermal treatment	DUAL RAM, CROSS CHANGE-systems	8
	AIR BACK-system	9
	MOIST CONT, OPTI TEMP, AIR LOG-systems	10
	ECO VAC Exhaust air control system	11
	Advanced modular design	12
Tension generation	GUS TEC-Pull Roll Stands and Measuring Rolls	13
Pick up Treatment	DIP MATIC-Dip solution saturation	14
	ECO PRESS-Squeezing device	15
	TWIN VAC-Dewebber system	16
Fabric guiding devices	Common function characteristics	17
	Centre Guide	18
	Full Width Spreader	18
	Duo Expander	19
	Trio Canter	20
Fabric softener	PARA FLEX, ROTO FLEX	21
Winding systems	CONTRO WIND-Centre driven Let-Off station	22
	ROLL STAR-Surface Winder	23
	CORD WRAP-Weighing and wrapping unit	24
Process control-CORD TEC	CORD VISU-Process parameter visualization	25
	CORD DATA-process data storage and utilization	26
	SPLICEMAN-Splice management	27
	CORD DIAG-Diagnostic and help system	28
	Electrical hardware	29
Dip solution preparation	AUTO MIX-Automatic dip solution preparation unit	30
References / Contact	References, addresses and masthead	Back cover

# Benninger Zell

A subsidiary of the Benninger AG, Switzerland



Benninger Zell GmbH (Germany)



Head office: Benninger AG (Switzerland)

**Benninger of Switzerland has been leading the way in the textile industry with branches and service representatives throughout the world for more than one hundred and fifty years. Benninger develops and manufactures textile finishing and tire cord products and supplies complete system solutions. Benninger's wealth of knowledge in the area of controls and automation comes as a result of many years' experience working with machines and products, in the textile industry and others.**

Founded as Maschinenfabrik Zell in 1898, Benninger Zell Germany is the mother company of the Tire Cord and Automation divisions. Benninger has been setting the standards in the manufacture of complete installations for treatment lines for tire cord, single ends and conveyor belts for decades. As the market leader, Benninger's technology guarantees total reliability and the highest possible quality. Its one-stop complete solutions make Benninger the company of choice for technical textile manufacturers, tyre manufacturers and companies in the chemical fibre industry.

### **Fabric and yarn treatments for the most challenging requirements.**

Benninger tyre cord and single end impregnation systems are technologically mature, guaranteeing total reliability and the highest possible level of safety for treated fabrics in a range of different applications.

### **Main areas of expertise**

Benninger excels in the market in five areas of expertise

- Comprehensive process know-how, consultancy and project planning
- Professional project management
- Innovative, reliable products

- Customer-focused service through start-up support and individual solutions
- Automation and engineering mechanics

### **Long-term business relationship**

Benninger's comprehensive understanding of the process is a significant factor in meeting customer needs, since this creates the necessary environment for cross-process consultancy and one-stop cross-industry solutions. We provide our customers with the right technology, the optimum solution for their plant, competent project management and the best service – twenty-four hours a day, seven days a week. These benefits enable us to establish long-term business relationships with our customers. We cultivate long-term business relationships with the world's leading tire manufacturers and





## Focus on customer benefits Mutual success is Benninger's goal

Learning from its customers and their needs, Benninger has been able to develop products which are innovative and consistently reliable. The focus of all our efforts is what is best for the customer and his needs.

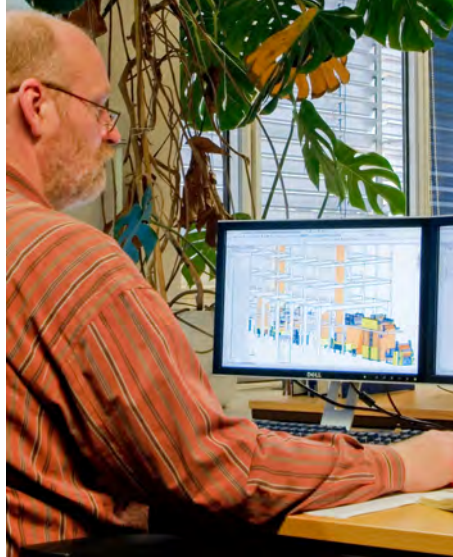

### **Saving energy .**

The environmental impact of products made on Benninger systems is excellent, particularly with the company's recently developed and patented ovens. ECO VAC for a reduced volume of exhaust air and EFF high efficiency motors are just two examples of energy saving solutions. The pull rolls motors also feed generated power back into the special DC supply circuit.

### **Saving chemicals**

With the new AUTO MIX- automatic dip solution, preparation batches are precisely prepared, and waste due to faults is avoided. The online dip consumption measurement device, DIP MATIC, enables chemicals to be batched to the exact lot. Its level control system continuously weighs the dip solution in the dip tank.



### **Reproducible quality and reliability**

With decades of experience and the consistent implementation of knowledge management, not to mention a quality control system which is documented through certification, we are able to offer our customers high quality on a continuous basis. Absolute reliability is guaranteed through process observation, operating data logging and the central software control of all machine equipment.

### **Rapidly achieved profitability through efficient project handling**

Professional project management and in-house assembly and testing guarantee fast, intelligent, easy, start-ups on site. The first roll produced is therefore ready for sale, there is no waste.



### Technology solutions without compromise

- Advice, support and implementation by an experienced team of experts
- Comprehensive process know-how in raw materials, textiles and chemistry
- Expertise in treated fabric, chemicals, spinning and weaving, process parameters, recipe optimisation, quality control and process optimisation
- Large data base for many applications

### Long-term optimisation of operating costs

- Minimised operating costs for round-the-clock operation
- 30% less exhaust air by operating heating zones with exhaust-air control systems
- Energy retrieval through exhaust air treatment systems
- Minimised heat losses due to special heating zone isolation (100% leakproof)
- Optimised constant control of dip pick-up
- Fully automated preparation of dip solution according to customers' needs
- Optimised operating costs through efficient software control

### Manufacturing and safety standards

- The equipment is executed in accordance with the German VDE and DIN standards as well as in accordance with the CE standards of the European Union.

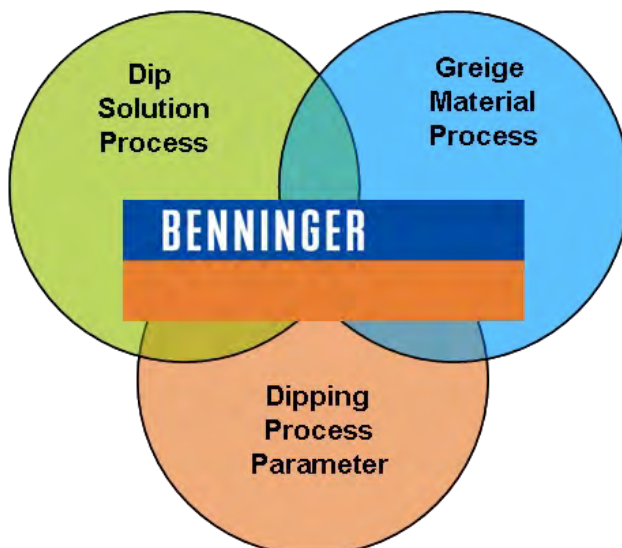
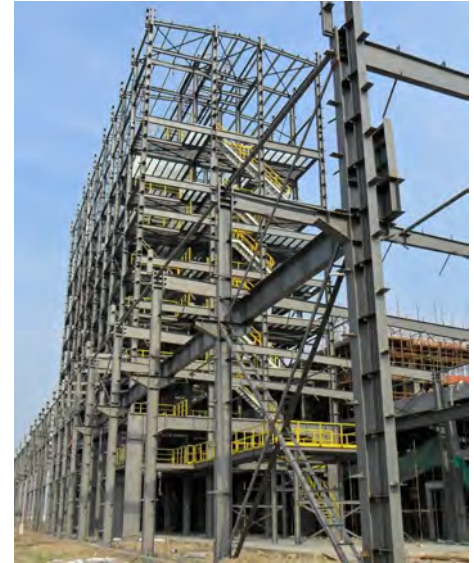
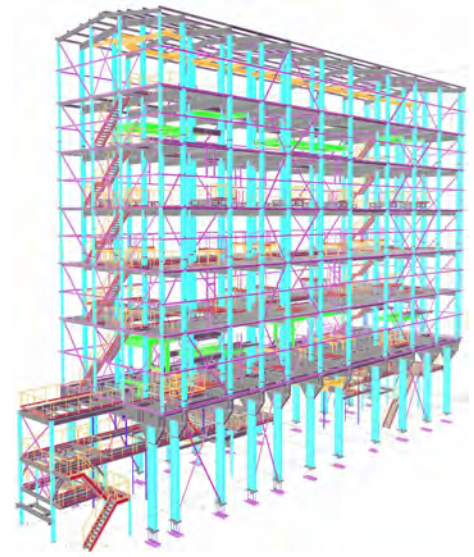

As leading manufacturer of treatment plants for Tire Cord, Benninger Zell is able to offer the benefits of a wealth of experience and know-how.



# Tire Cord Treatment Lines – At a Glance

## Flexibility for meeting the highest demands

Benninger manufactures tire Cord treatment lines. We design and supply tailor-made plants for heavy and / or lightweight fabric depending on the customer's needs.



Polyester Tire Cord fabric treating line

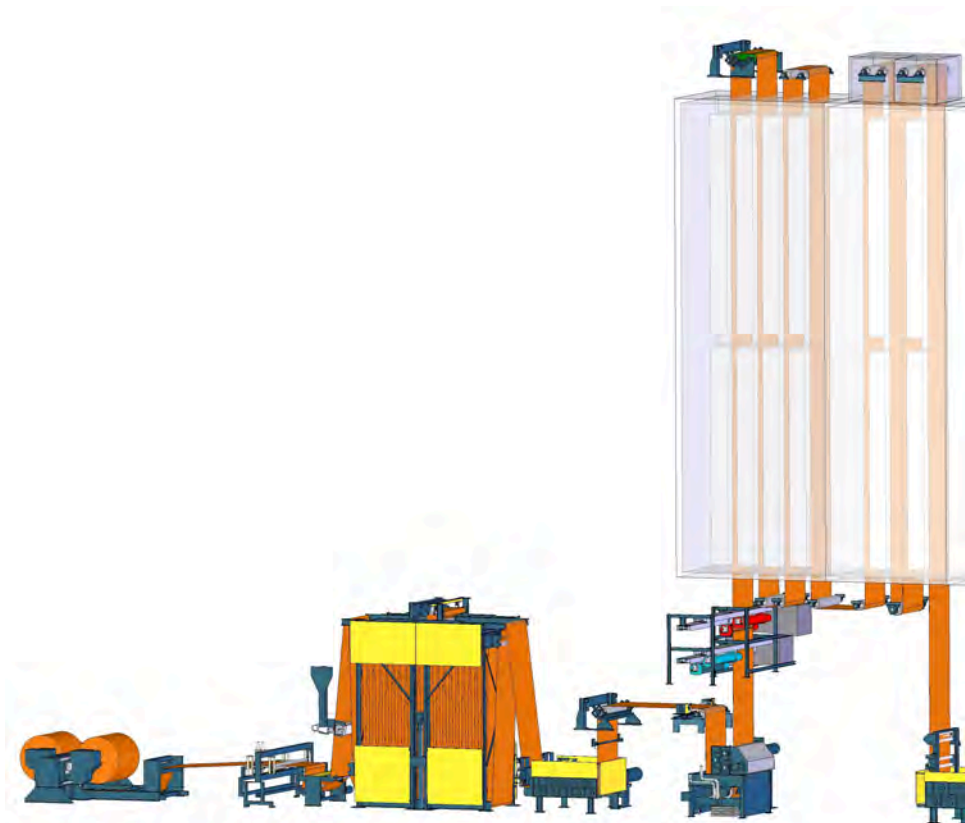

Polyamid Tire Cord fabric treating line

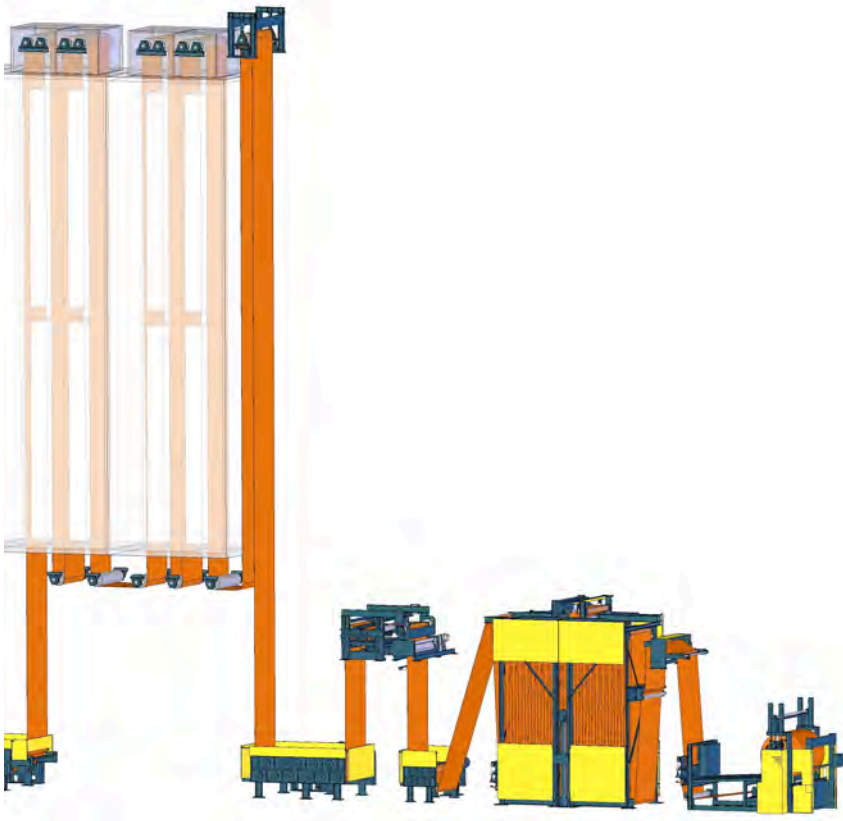

# Thermal treatment

## DUAL RAM, CROSS CHANGE systems

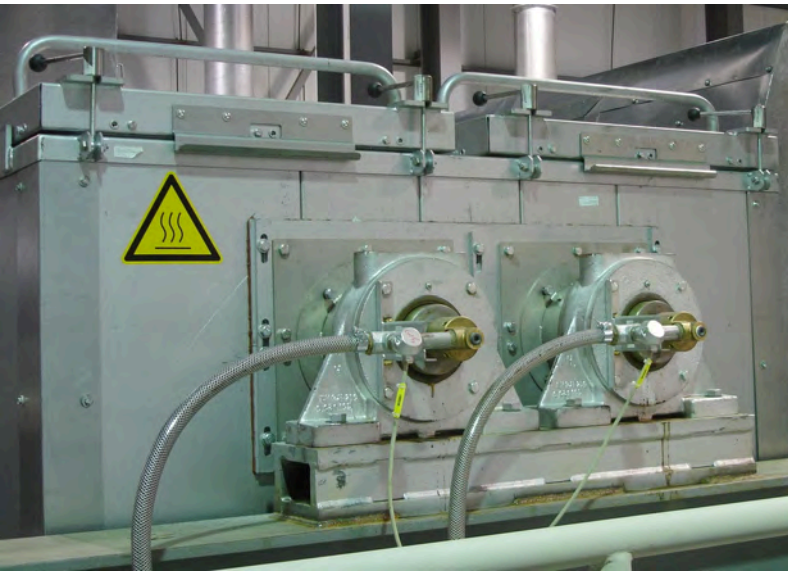

Roll chamber and roll bearings and cooling



Jet lips with minimized manufacturing tolerance

**Benninger's aim - 100% uniform, 100% reproducible thermal treatment. To achieve the required quality for parameters such as strength, shrinkage, elongation and adhesion, the oven settings must be kept within narrow tolerances. With Benninger's refined and patented new oven system, the required technological values are more than guaranteed.**

### DUAL RAM

- Even temperature distribution from top to bottom in each oven within a tolerance of less than +/- 5°C.
- The jet boxes of each oven are separated into a top part and a bottom part and each part has its own temperature control system. They are fitted with a burner or heat exchanger depending on the customer's requirements.
- The temperature of the top and bottom parts can be adjusted and controlled independently. The DUAL RAM system also supplies the optimum amount of air for each part independently, thus providing an excellent treatment balance throughout the entire oven.
- Due to their stable operating characteristics, burner efficiency is maximised throughout a wide range of working conditions. They are, of course, easily adapted to NG and/ or LPG. Wear-free operation means highly efficient, long-term use and minimised maintenance costs.

### CROSS CHANGE

- The CROSS CHANGE system significantly improves the uniformity of the oven conditions. The air is extracted from the bottom of the oven and returned to the top through the upper jet boxes and the extracted air from the top is blown back to the bottom through the lower jet boxes. This provides uniform conditions throughout the oven. Benninger owns the patents for this combined system throughout the world.

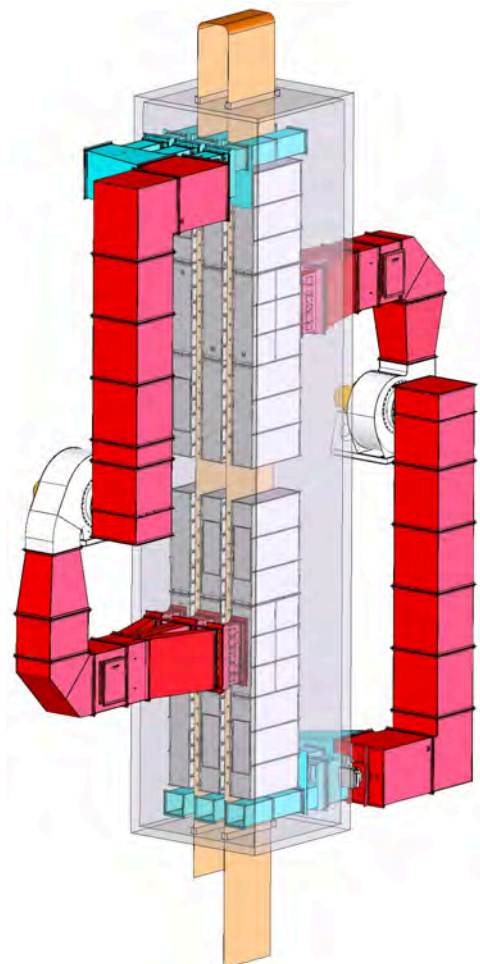

DUAL RAM system and CROSS CHANGE system



# Thermal treatment

## AIR BACK system



Part of circulation air system

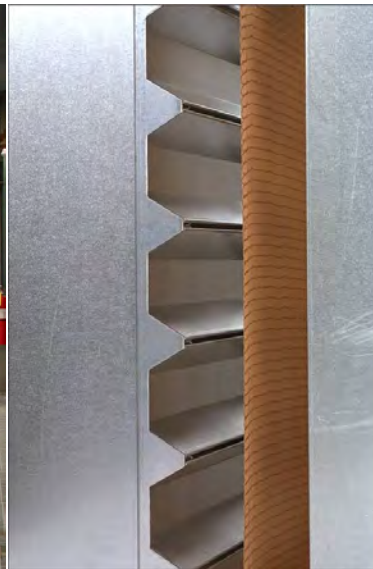

Jet box nozzles from out side



Jet box nozzles from inside

**Uniform, highly efficient fabric impingement minimises fabric vibration/flubbing, which is particularly important for lightweight fabrics.**

### AIR BACK

- With suction ducts above and below each jet box row, the AIR BACK system provides, a uniform, symmetrically distributed airflow of the return air. Low return-air velocity is important and necessary near the fabric. Inverter controlled circulation and exhaust air fans allow exact presets according to the product /production requirements.
- The AIR BACK system is also covered by the global patents.
- These features provide excellent line efficiency.

### Other features

- Uniform air supply and air velocity at the nozzles. Precision nozzle gaps within a tolerance of less than +/- 0.2mm.
- The well calculated number of jet nozzles arranged at short intervals make for efficient heat transfer
- Since the return air is extracted from the bottom, the amount of cold air flowing into the oven through the fabric slots is minimised. With the resulted reduced soiling the need for cleaning is also reduced, as is the risk of fire.

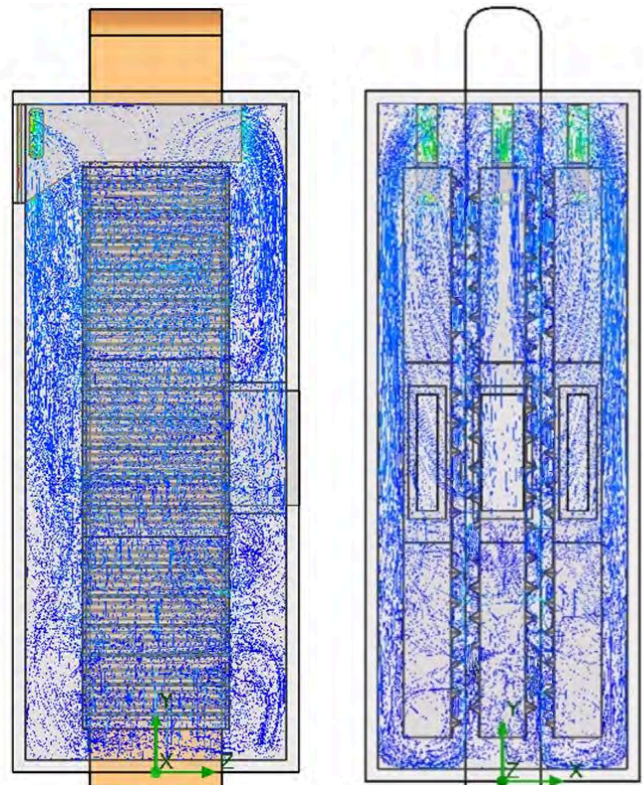

Uniform air flow by AIR BACK system

# Thermal treatment

## MOIST CONT, OPTI TEMP, AIR LOG systems

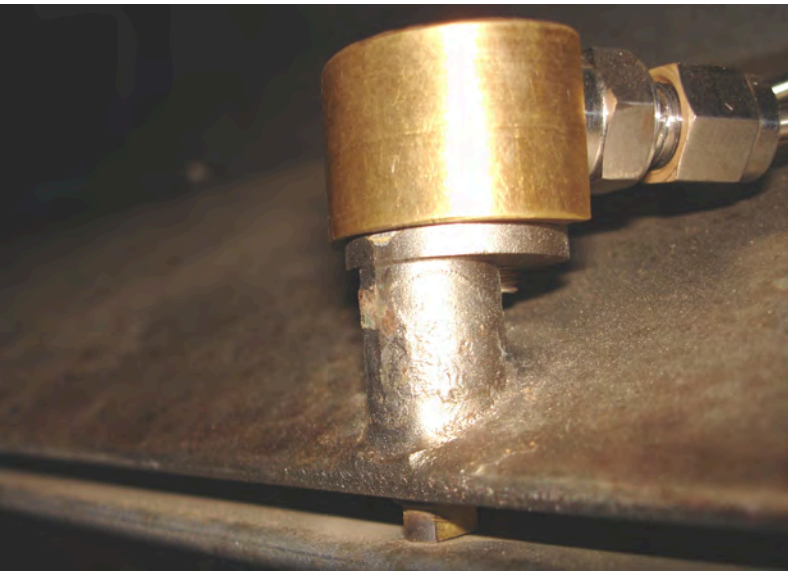

AIR LOG Sensor

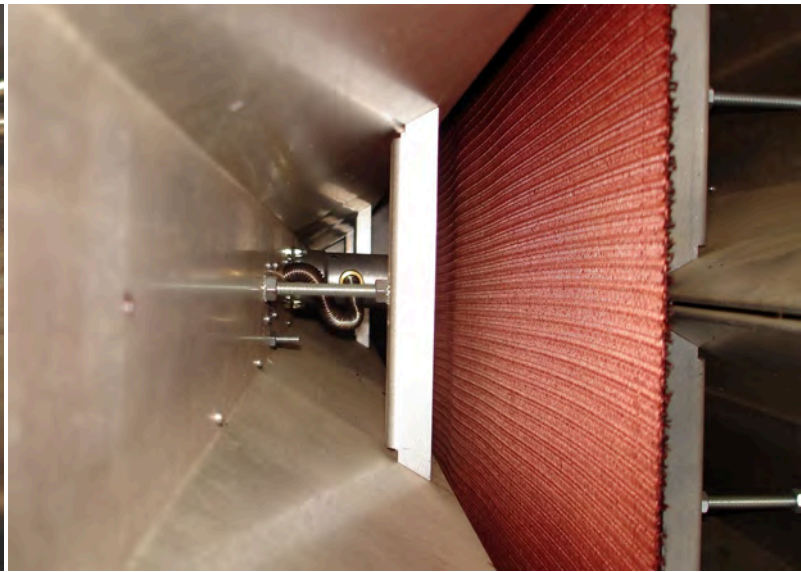

OPTI TEMP Sensor

Heat treatment conditions must be measured and controlled to achieve the highest tire-cord quality. Another important factor is the minimised energy costs. Three advanced systems are installed to make it easy to evaluate and monitor for perfect heat-treatment conditions.

### MOIST CONT

- To achieve the optimum results, the residual moisture content of fabric in the drying zones must not be allowed to exceed a certain level before entering the stretching zone.
- The MOIST CONT moisture measuring/controlling system improves treatment and product quality, prevents over drying and minimises energy waste.
- The drying zone temperatures will be reduced to achieve the required fabric moisture content.

### OPTI TEMP

- The final fabric properties are in direct relation of the fabric temperatures. Optimised and controlled fabric treatment through the fabric temperature is further enhanced to meet the requirements.
- The OPTI TEMP - fabric temperature measurement system provides the optimum heat treatment, makes for perfect product properties and monitors the treatment quality. A record of the temperatures provides additional proof of the product quality.

### AIR LOG

- The air velocity measuring system AIR LOG improves adjustment and treatment reliability. The air speed at the nozzles is adjusted by means of the real time air velocity display.
- Any deviation from the settings is detected and shown on the display, thus improving reliability.

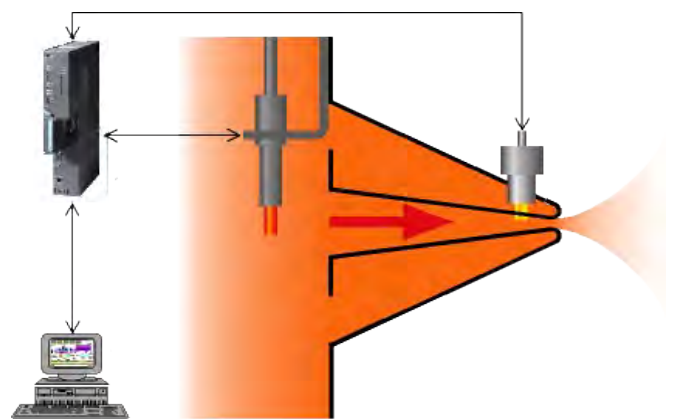

Heating zone control circuits

### Unique features from Benninger

- DUAL RAM heating system
- CROSS FLOW air exchange
- AIR BACK return-air guiding
- AIR LOG air velocity measuring sensor
- High heat transfer rate due to the high number of jet lips



# Thermal treatment

## ECO VAC-Exhaust air control



Exhaustor

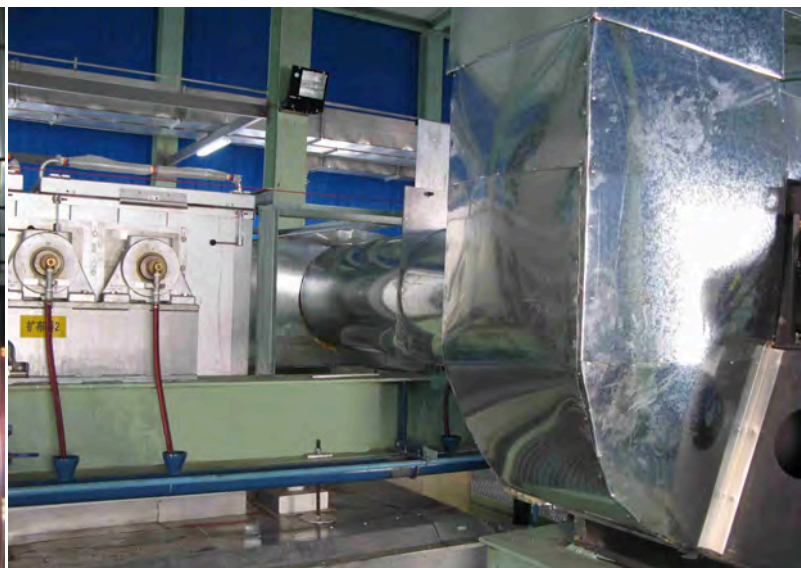

Roll chamber exhausting

**ECO VAC reduces exhaust-air by 30%. Each oven is fitted with an ECO VAC system. With the ECO VAC system the vacuum in each oven can be adjusted individually. Controlling this vacuum minimises the exhaust-air volume, regardless of fluctuating heat-treatment conditions.**

### Benefits

- Minimising the amount of exhaust air reduces the energy costs. The exhaust air volume is reduced to a minimum taking into consideration variations in the atmospheric pressure and the precision control of the set difference between the atmospheric pressure and the pressure inside the heating zone.
- Inverter-driven exhaust fans blow out the amount of air thus optimised, regardless of any change in the treatment and/or atmospheric pressure.
- Air conditions for the personnel are improved and the need to clean of the building is further reduced.
- Using the ECO VAC along with the additional roll chamber significantly reduces the amount of volatile substances exhausted inside the building.

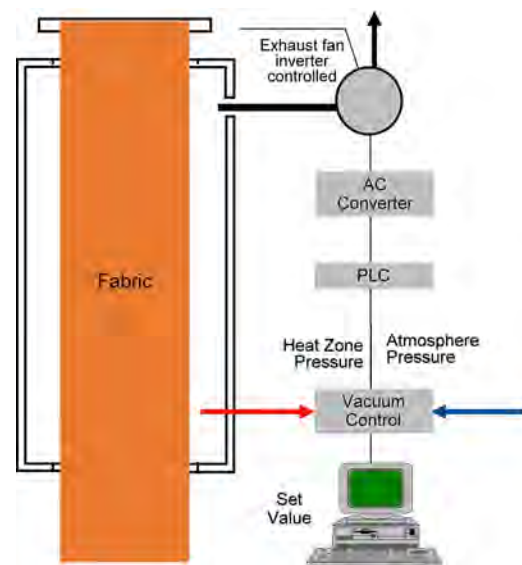

ECO VAC control system

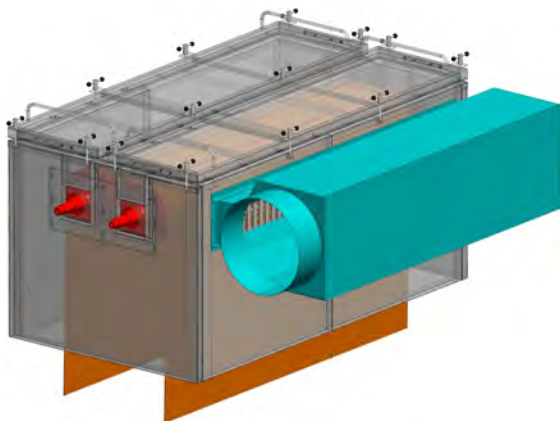

Roll cover exhaust

### Unique features from Benninger

- 30% saving on exhaust air
- Fully automated control of exhaust air flow rates
- Reduced volatile substances inside the building



# Thermal treatment

## Advanced modular design

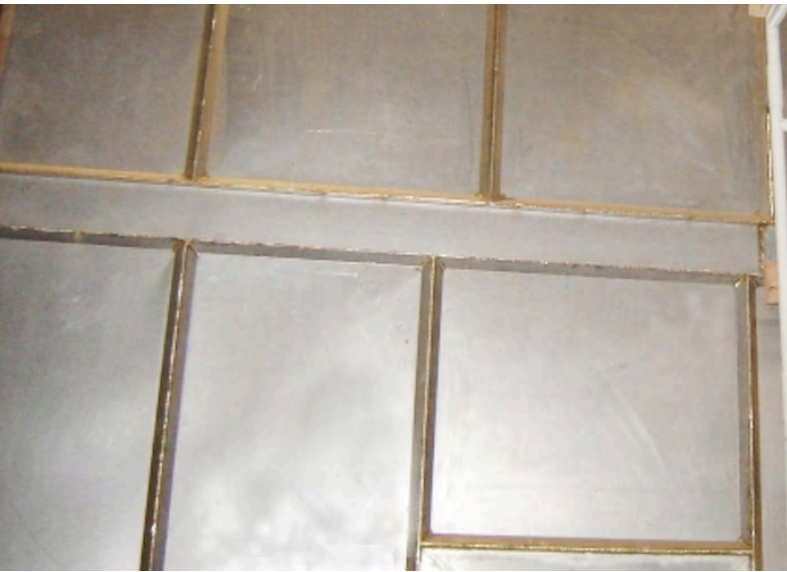

Insulation plates arrangement tight welded



Insulation plates arrangement

**Benninger Zell offers state-of-the-art systems - absolute seal. The difference is obvious. Apart from operating in ideal temperature conditions, this oven is durable and requires minimum upkeep. The optimum, durable heat insulation and minimum fire risk are absolutely crucial for tire cord ovens. Sealing of the insulation is guaranteed by the modern sheet metal design and special welding technique.**

### Insulation

Silicone loses its sealing properties in the hot environment due to hardening. Fumes penetrate into the panels and escape to the outside. Thus oils and oligomers condense and this leads to a reduction in insulation efficiency and an increased fire risk.

### The benefits of the Benninger solution

- All insulation and connection joints are perfectly sealed by the leakproof welding technique. The special design prevents leaking due to distortion caused by heat expansion, since the expansion movements of the insulation panels are absorbed.
- Corrosion-free, aluminium plated sheet metal provides durability for the insulation panels and the special welding wire makes for corrosion-free seam welds. The stable steel construction is another essential feature.
- Significant advantages are: stable insulation efficiency, reduced fire risk and hugely reduced maintenance.

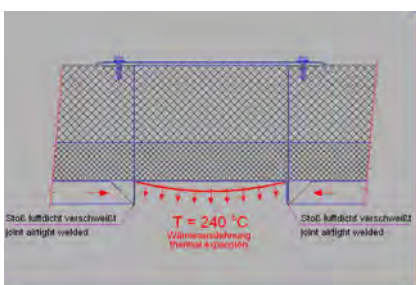

Absorption of heat expansion movements

### Modular design

- The modular design of the oven reduces the oven dimensions. The size of the steel structure of the oven, the size of the building and the quantity of air ducts is also reduced which leads to reduced costs.

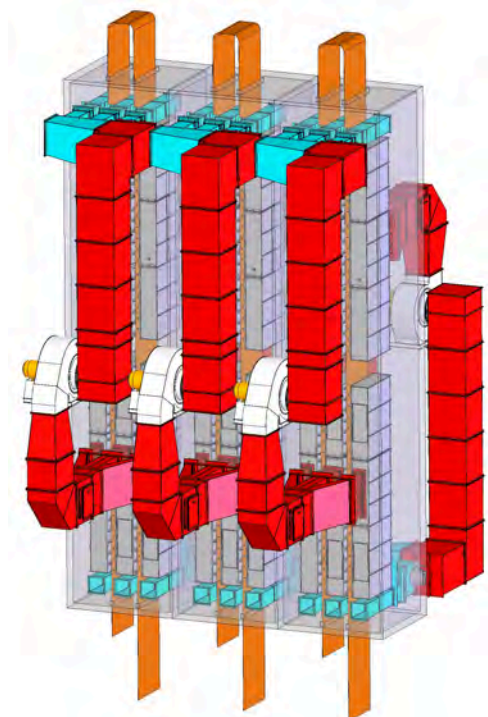

Modular design

# Tension generation

## GUS TEC-Pull Roll Stands and Measuring Rolls

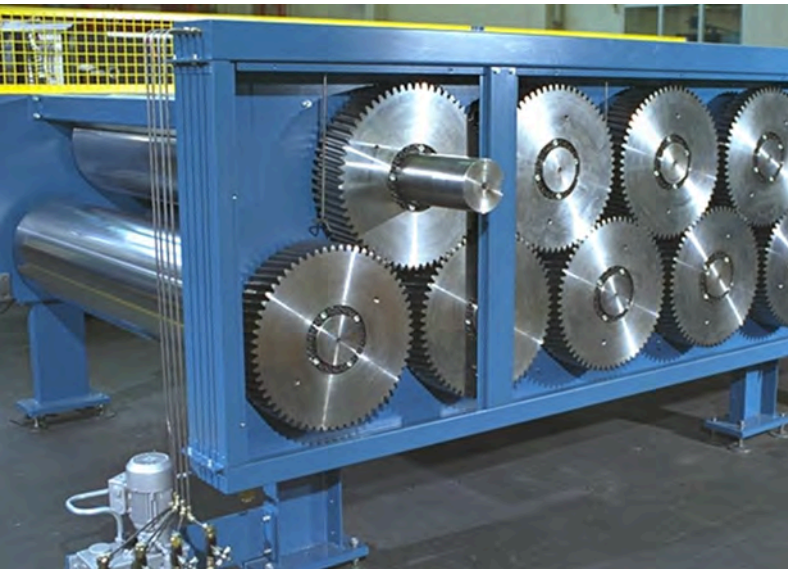

Pull roll stand drive with automatic central lubrication



Hardened and ground helical gears

One important treatment parameter for achieving high quality in tire cord production is stable, precisely controlled tension. Pull rollers produce the necessary process tensions and transport the fabric through the entire machine. Pull roller stands and measurement rollers placed at the optimum distances guarantee precise, stable fabric tensions, precisely controlled by the CORD TEC process control system.

### GUS TEC pull roller stands produce the fabric tension

- Minimised roller deflection prevents cord accumulation and fabric folding
- Energy regenerating and low maintenance AC-drives
- Fast roller/bearing change due to the modular design

### Silent operation and long service life

- Hardened and ground helical gears
- Automated gear lubrication
- Cast iron blocks to reduce vibration

### Constant build-up of tension across the width

- Rollers with precise cylindrical geometries and concentric build-up
- Gentle fabric guidance by smooth-ground, roller surfaces

### High-precision tension control

- Measurement rollers with highly sensitive load cells
- High resolution digital signal processing

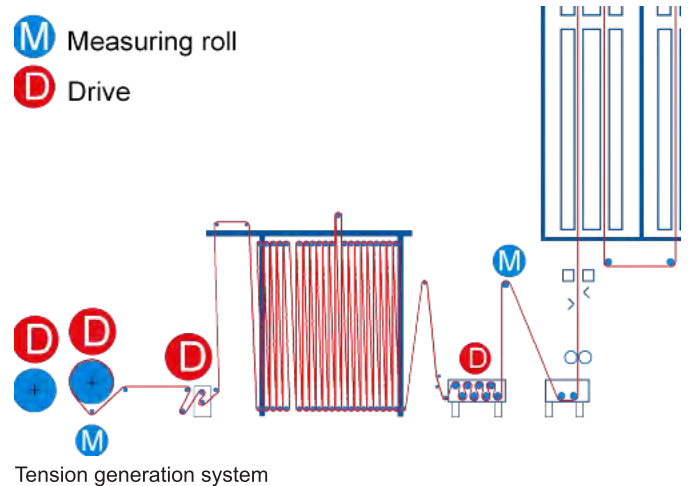

### Unique features from Benninger

- Hardened, ground helical gears
- Silent operation and force transmission through helical gear wheels
- High-precision tension control
- Modular design



# Pick up treatment

## DIP MATIC fabric saturation



DIP MATIC Dip Station

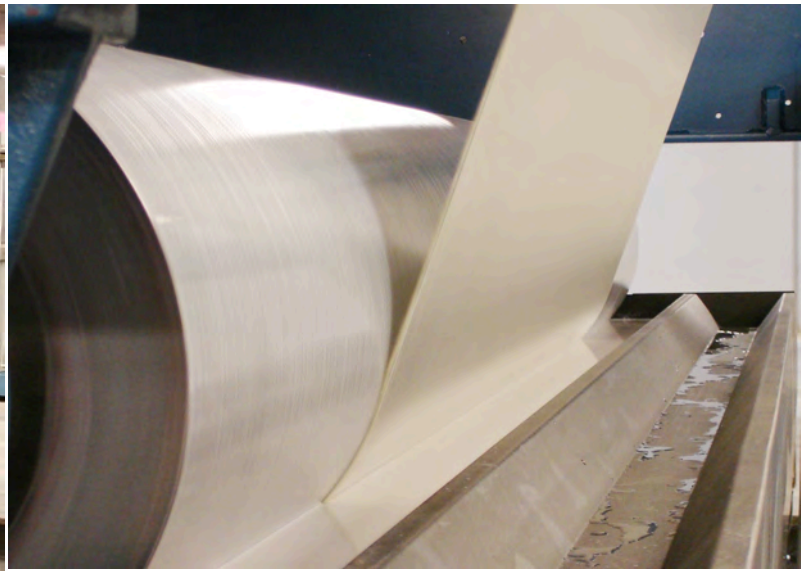

Application of dip solution

To achieve the optimum adhesion between the fibres and the rubber compound, the fabric is treated with an aqueous latex solution. An aqueous Pre Dip must first be applied to PET Cord fabric. The aim of the pickup is uniform dip pick-up across the fabric width for maximised and uniform adhesion of rubber also at all dip penetrations.

### Features

- DIP MATIC provides online dip consumption measurement, indication and level control by continuously weighing the dip solution in the saturation tank.
- Adjustable fabric inlet angle for minimum foaming.
- Minimum tank size for the continuous supply of fresh dip solution to minimise waste and sedimentation by pre-dip solutions.
- Free access to the dip liquid in the saturation tank • The dip roller is covered with a special non-stick coating, which minimises foaming and prevents dip deposits forming on the roller surface
- Cleaning minimised by non-stick coating on tank and rollers.
- The filter integrated in the latex return system from dewebber prevents the return flow of dirt.

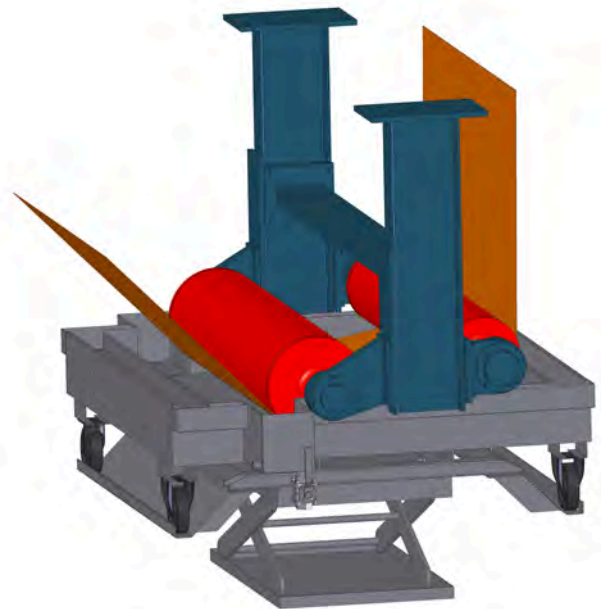

DIP MATIC-DIP Station



# Pick up treatment

## ECO PRESS-Squeezing device

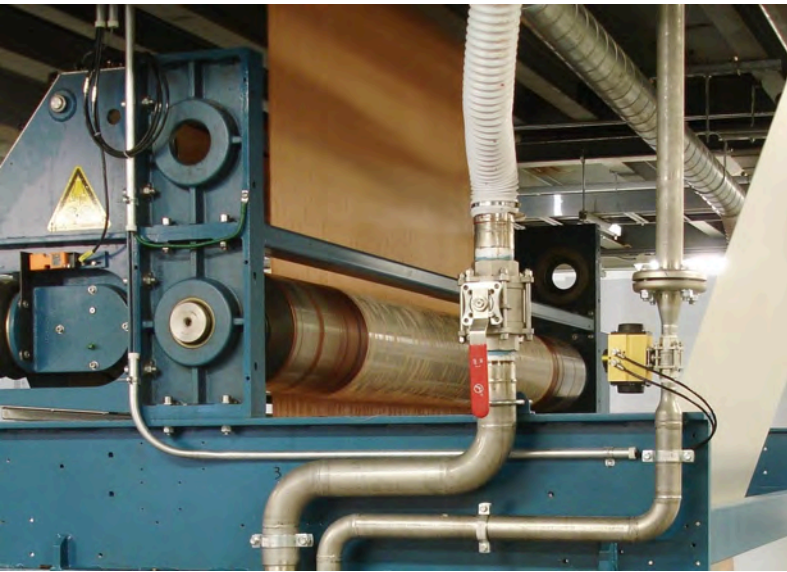

ECO PRESS squeezing device

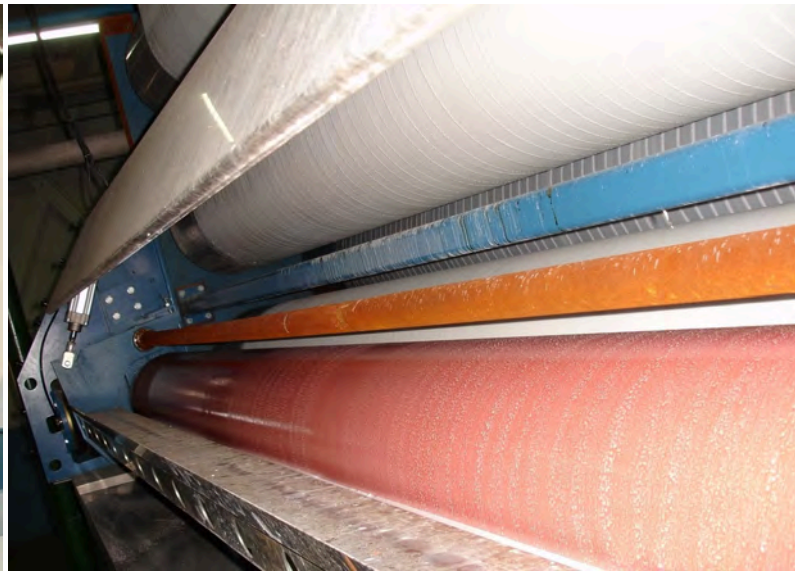

Squeeze roll with scraper

Once the fabric has been coated, the surplus dip solution on the fabric is removed by the squeezer. The ECO PRESS squeezer provides uniform squeezing pressure across the width, thus guaranteeing uniform wet pick-up and uniform dip penetration if required.

### Features

- Specially designed squeeze roller. Its deflection follows the bending of the counter roller. This produces a uniform squeeze pressure across the entire fabric width, which is essential for uniform dip pick up across the width.
- The squeeze roller is covered with a non-stick rubber cover and the counter roller is covered with a special non-stick coating, both of which prevent the buildup of dip on the roller surface.
- The pneumatically powered squeeze system facilitates squeeze pressure adjustments up to 4 daN/cm.
- A hysteresis-free, reproducible squeeze force is produced by membrane-type cylinders.
- The SQUEEZE BOOST system for implementing high squeeze pressure as the splice passes prevents excessive contamination from subsequent aggregates, mainly the first drying zone

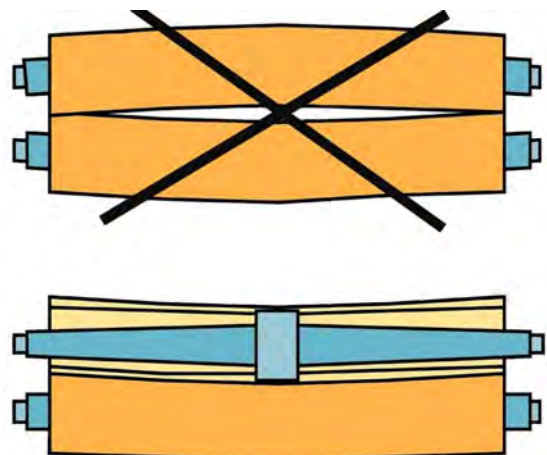

Special squeeze roll of the ECO PRESS

### Unique features from Benninger

- DIP MATIC online dip consumption measurement
- ECO PRESS squeeze unit with squeeze roller which adapts to curvature
- Reduced consumption of chemicals



Membran-type cylinder

# Pick up treatment

## TWIN VAC-Dewebber system



Dewebber System - model TWIN VAC

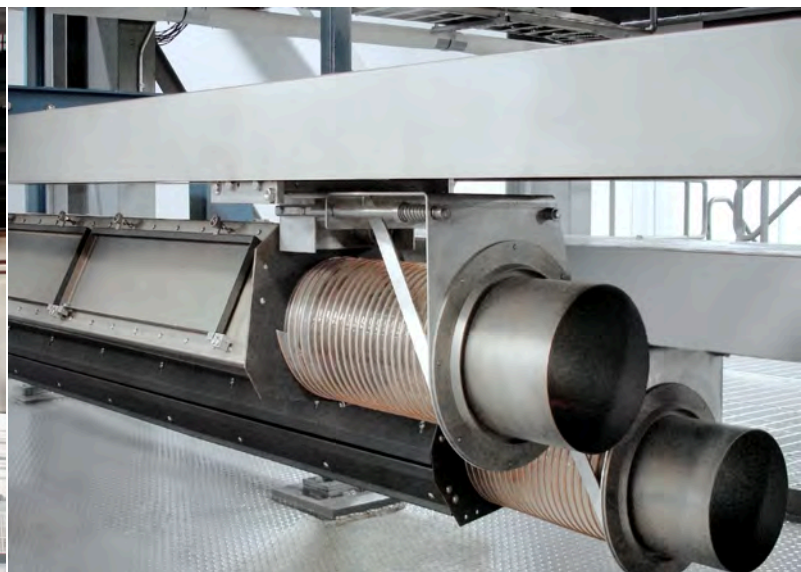

Automatic retractable dewebber heads

Once the surplus dip solution has been squeezed out, the fabric passes the dewebber heads which define the dip pick-up. Constant extraction is guaranteed across the entire fabric width and can be controlled individually at each dewebber head. Lateral retraction of the dewebber heads is fully automated.

### Capability

- Uniform dip pick-up across the entire fabric width due to constant vacuum from optimised dewebber heads
- Minimum loss of production and constant high efficiency when run with 4 dewebber heads (2 in operation / 2 on standby)
- Flexibility for defined Dip Pick Up since the vacuum for each head can be adjusted individually
- Process reliability enhanced by controlling the set vacuum for constant dip pick-up
- Dust emission reduced by a filter system
- Line efficiency increased by continuous line operation facilitated by automated movement of dewebber heads
- Cleaning and maintenance minimised and eased by Teflon coating inside the dewebber heads and collection boxes.
- Versatility enhanced by adjustable suction gap for adaptation to products.

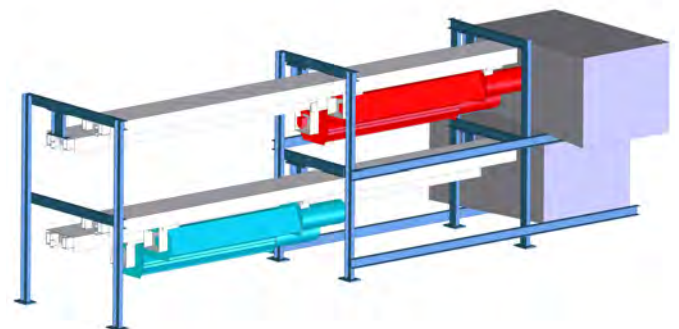

TWIN VAC dewebber system

### Unique features from Benninger

- Constant extraction across the width
- Automated retraction of dewebber heads.
- CLEAN FIX automated cleaning system for dewebber lips

### CLEAN FIX dewebber lips cleaning system

- Keeps slots clean for uniform extraction
- Integrated in each head
- Freely selectable cleaning cycle



CLEAN FIX, cleaning pin



# Fabric guiding devices

## Common function characteristics

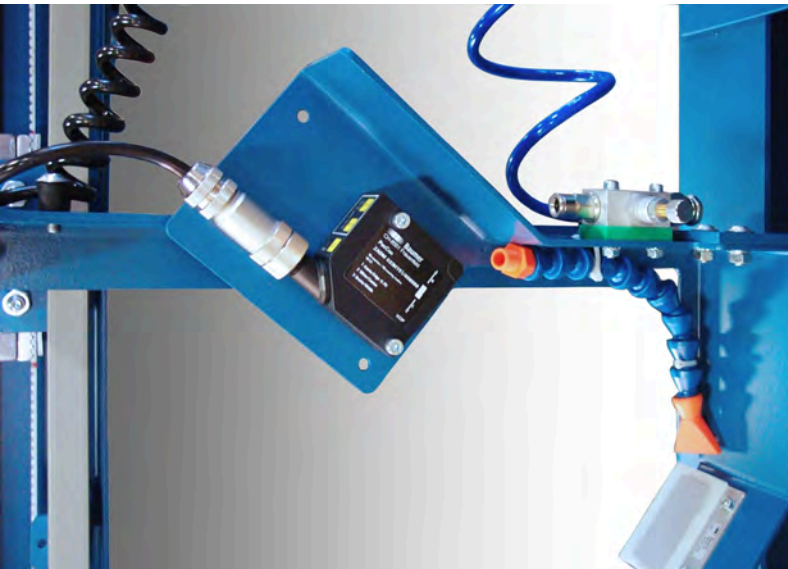

Optical fabric edge sensor with cleaning tool



Control cabinets for guiding devices with movable operator panel

**Constant operation with a centred fabric run at the desired fabric width and uniform cord distribution is essential to achieve the optimum product quality and productivity. Benninger therefore provides fabric guide systems, designed in-house with OE technology (optical edge detection and electrical actuators) - centre guide, full width spreader, duo expander and trio canter, each designed for a designated purpose.**

### Flexible control system and OE technology

- PLC-based controllers make it possible to adjust to a wide range of fabric styles and guide variations
- High-resolution optical edge detectors for detecting the edges of the lightest weight fabrics
- Hydraulic or pneumatic installations replaced by efficient electric motor actuators

### Automatic adaptation to fabric style and fabric width

- All settings integrated into the treatment recipe
- Settings automatically engaged by SPLICEMAN splice management system

### Safe and easy manual tooling-up and operation

- Local control panel with display for manual settings
- Pre-selected width, locally adaptable
- Automatic system implemented by fabric edge detection

### Unique features from Benninger

- All guiding devices can be adjusted individually
- Adjustment fully automated by recipe management
- Automated engagement by SPLICEMAN system
- Movable local operator panel with display
- Single devices for stand-alone solution available for easy refit

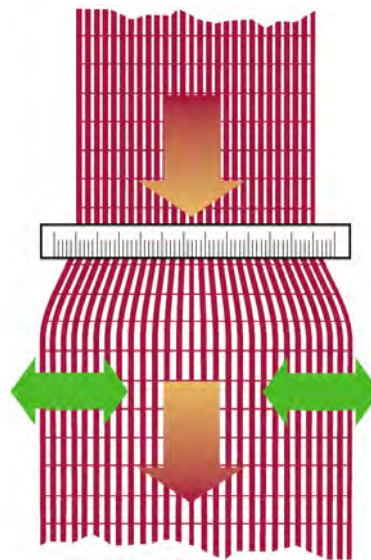

Principle of edge sensor frame



Movable operator panel



# Fabric guiding devices

## Centre Guide

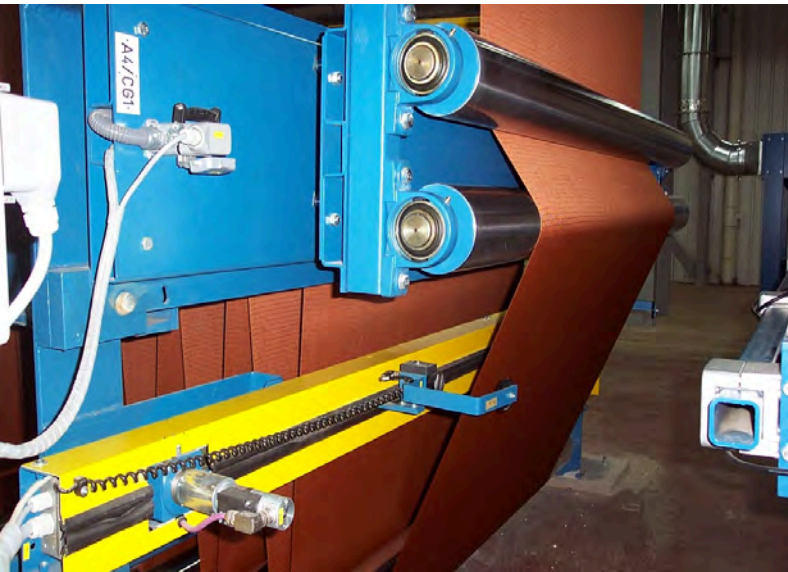

Centre guide with swivelling frame

The centre guide makes sure that the fabric is guided down the centre of the line. The fabric is centred by the rollers moving and swivelling.

### Features

- The fabric is centred along its route through the line.
- Self-adjustment to the fabric width is achieved by scanning for the fabric edge.

### Places where installed

- Important for the accumulator inlets and the outlets

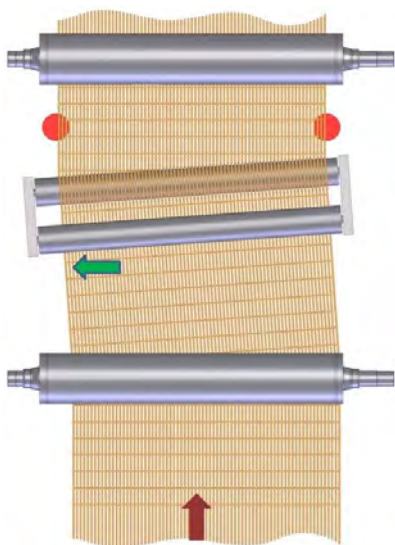

Principle of Centre guide

## Full Width Spreader



Full width spreader

The Full Width Spreader spreads the fabric to a set width at the high tension zones. This facilitates uniform cord distribution across the entire width.

### Features

- Two independently controlled sets of rollers spread the fabric to the set width left and right.
- Slight centring effect is achieved by a centred symmetrical arrangement of roller sets.
- The spreading efficiency is adjusted by varying the angle of the roller set to the fabric.
- The optimum spreading effect is achieved by a highly effective grip provided by the special ceramic coating.

### Places where installed

- In front of the pull roll stands and between the ovens

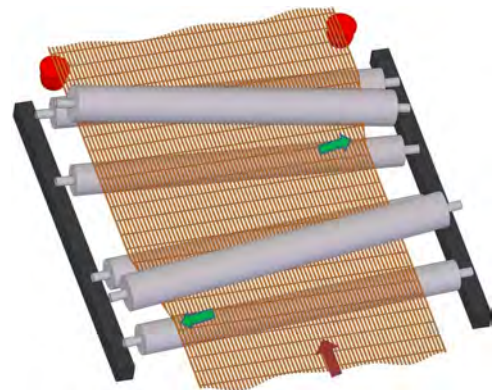

Principle of Full Width Spreader

# Fabric guiding devices

## Duo Expander

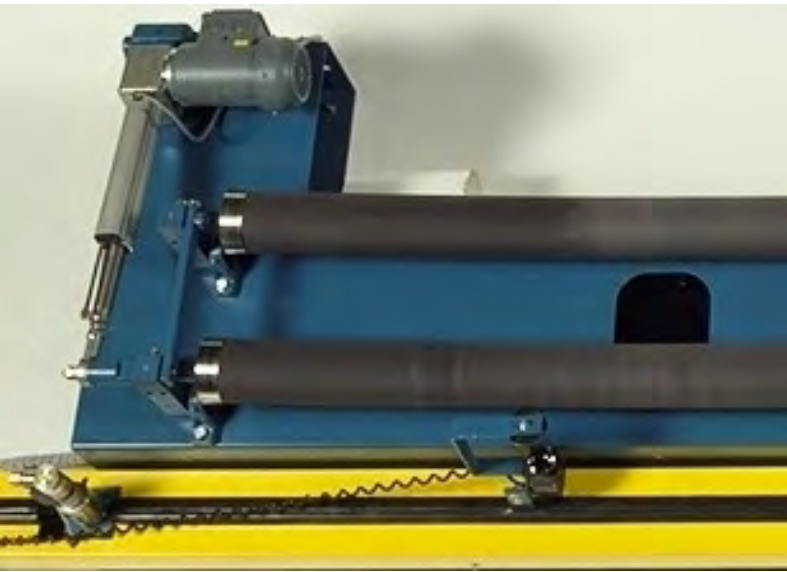

Duo Expander

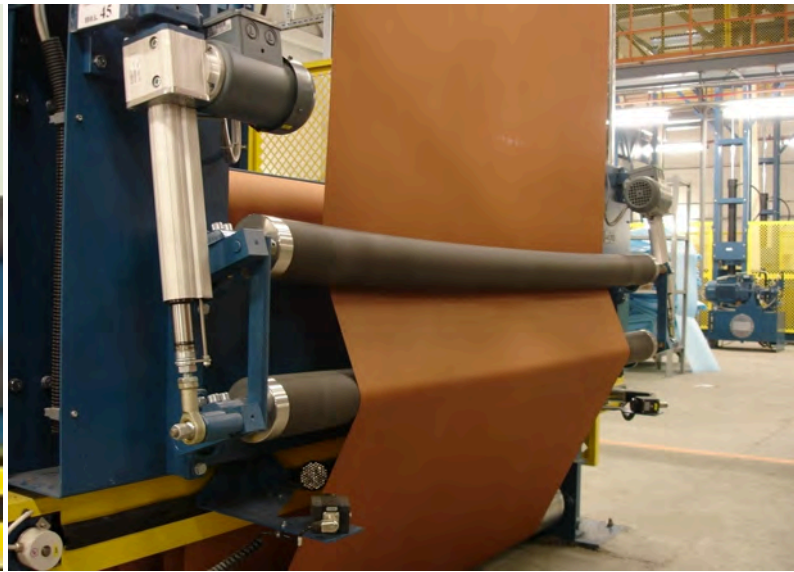

Duo Expander in operation

**The Duo Expander spreads the fabric in low-tension zones by maintaining or providing uniform cord distribution across the entire width**

### Features

- Spreads the fabric to the set width, left and right via two bow rollers linked to one another
- Each side operates individually via the independently controlled bow roller.
- The optimum spreading effect is guaranteed by the highly efficient grip of the rubberised roller surface.

### Places where installed

- Upstream of the low-tension pull roller stands, essential before the surface winder and in big accumulators.

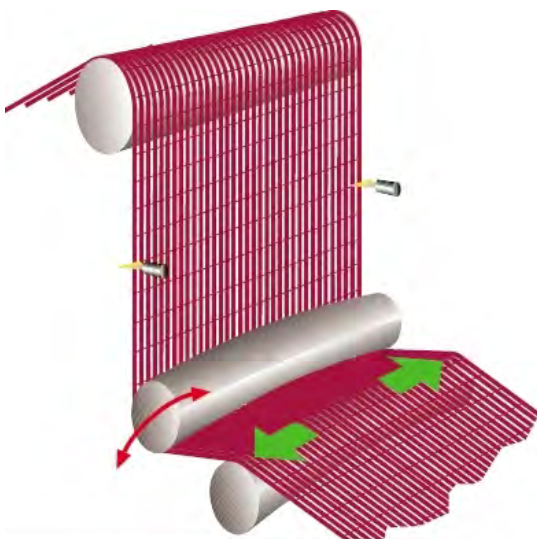

Principle of Duo Expander



# Fabric guiding devices

## Trio Canter



Edge guiding/spreading – Trio Canter

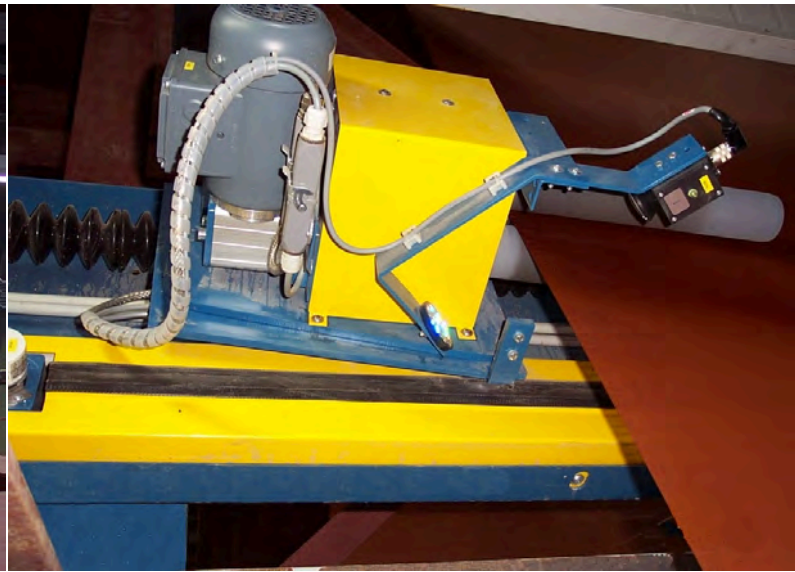

One side function unit

**The Trio Canter prevents increased cord density at the edges and maintains the exact set width of the fabric.**

### Features

- Each side is individual adjustable and operates via two individually controlled actuator sets.
- Prevents cord accumulation at the edges of the cord fabric by spreading the fabric edges to the set width, left and right.
- In particular, provides a precisely controlled edge built-up at the winder.

### Places where installed

- Upstream of important treatment steps, indispensable before dip stations and in the surface

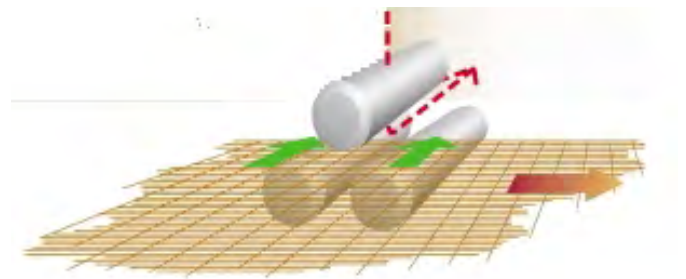

Principle of Trio Canter

# Fabric softener

## PARA FLEX and ROTO FLEX systems



PARA FLEX-Softener



ROTO FLEX-Softener

Today's raw materials and new tire-making technologies require the tire cord fabric to have additional properties. The various polyester tire cord fabrics which are used in particular require a so-called "soft" cord. Benninger also caters for this and offers solutions which satisfy almost all the highest standards whenever soft tire cord is required.

### PARA FLEX (knife-type softener)

This type is intended to be used to apply the basic or standard degree of softening to tire cord fabrics. It is designed to be highly flexible in order to achieve different softening effects.

#### Features

The different softening effects are mainly achieved by varying three adjustable parameters.

- By using one or two pairs of blades
- By varying the fabric bending angle. With AC motors, this is continuously adjustable from 0°- 90° for each pair engaged.
- By varying the fabric tension. This is precisely maintained by the measurement-roller-based tension controller. Other features
- The blades are made of stainless steel and are chromium plated so that they have a long service life.
- There is a highly efficient blade-suction and brush-roller device for removing excess dip coating.
- The blades are water-cooled, which prevents them from heating up and scraping off excessive amounts of dip pick-up
- There is a highly efficient static eliminator installed.

### ROTO FLEX (gear roller softener)

The ROTO FLEX makes for very special softening characteristics – especially when used in combination with the PARA FLEX. Benninger owns the patents for the ROTO FLEX throughout the world.

#### Features

- Softening is gentle, since the fabric is bent between pairs of motor-driven gear rollers, so that the fabric is not subjected to scraping. Each roll of a pair is driven by an AC motor to facilitate a wide range of adjustments.

Possible adjustments to produce the necessary softening effect

- by the degree of bending. Can be adjusted by varying the distance between the gear rollers
- by using gear-roller pairs with a different tooth shape.
- by adjusting the speed differences to the fabric
- by adjusting to of a different angle/gap between the teeth flanks of a gear roll pair.

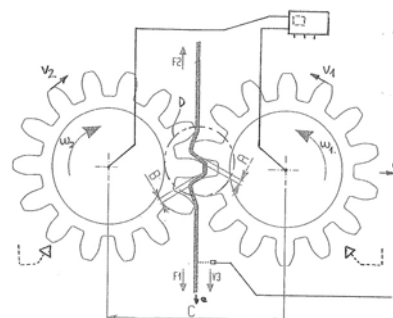

Principle of ROTO FLEX



# Let-off stations

## CONTRO WIND-Centre driven let-off station



Dual centre driven Let-Off station with automatic fabric centring



Dual centre driven Let-Off station with generating motor brake

**The first step to perfect treatment: Start feeding the line by unwinding the fabric at the CONTRO WIND advanced dual let-off station. Two centre-driven let-off stations make sure the fabric is fed in under constant let-off tension. The let-off stations are fitted with AC motors. The lateral movement of both stations is automated to achieve optimum fabric centring.**

### Features

- Generator braking by AC motors
- Constant precision let-off tension ensured by measurement-roller-based fabric-tension control system
- Motorised, gap-free shell fixing by tooth adapters
- Fabric roll centred by laterally moveable supports
- Conveyor belt feeds in the un-wound fabric lead automatically
- Reverse motion for fabric tensioning unit



Toothed drive shaft



Drive shaft and toothed adapter

### Benefits

- Energy saved by feed back of brake energy
- Maintenance costs minimised by wear-free function
- Fabric centred to line centre
- Excellent concentric running with no radial run-out, even at high line speeds

### Unique features from Benninger

- Energy costs reduced by motor braking
- Minimised parts wear - and maintenance costs
- No radial run-out with shell fixing
- Fabric-roll centring

# Winding systems

## ROLL STAR-Surface winder

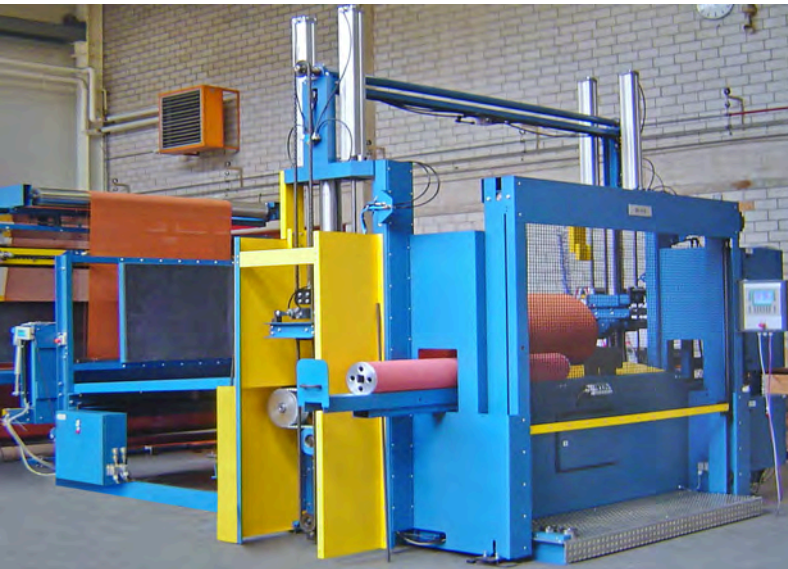

ROLL STAR-Surface Winder with shell preparation

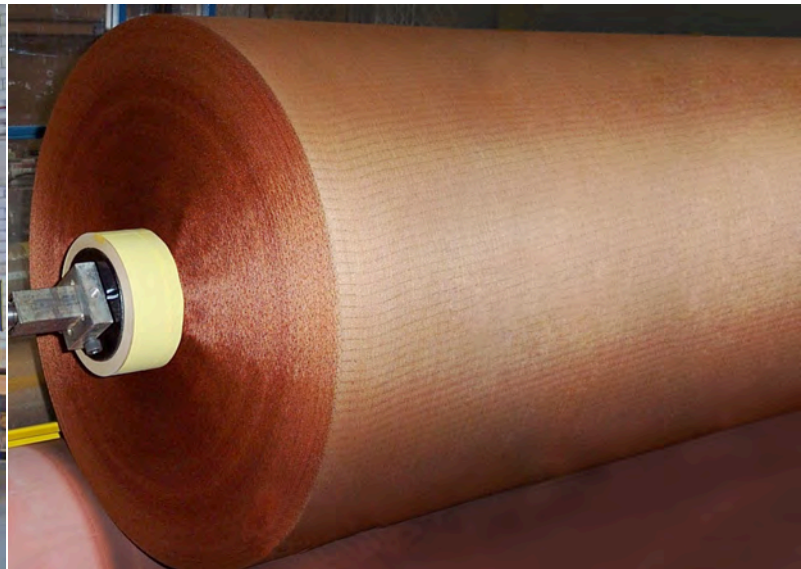

Straight edge winding-up

### Last step of the perfect treatment

The ROLL STAR surface winding system produces the perfect fabric roll, ready for despatch. Your fabric roll represents the quality of your production and your company.

### Roll build up

- Winding density/roll hardness adjusted for all fabric types and according to customer requirements by decoupling the intrinsic weight of the fabric roll. This is enabled by the controlled press-and-release force of the ROLL STAR winding load controller
- Straight, "star free" edge build-up facilitated by the adjustable winding density/roll hardness and the integrated guiding devices, Duo Canter and Trio Canter. A perfect, measurement-roller based fabric tension control system is also important.

### Handling, roll change

Quick, easy and safe roll change facilitated by the

- Automatic roll kick-out system
- Lateral shell loading position
- Automatic chuck adjustment to the shell centre
- Integrated crosscutting FABRIC CUT. Automatic at defined length or manual release

### Special safety measure

- Safe operation facilitated by the integrated safety curtain in front of the ROLL STAR. Prevents personal injury and unforeseen line stops due to accidental access.

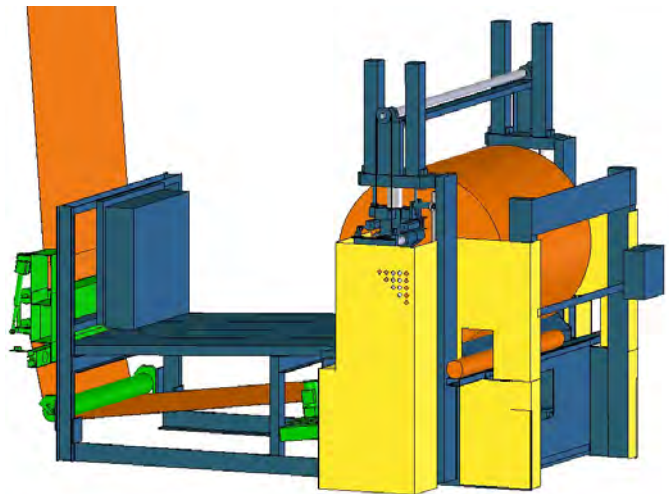

ROLL STAR-Surface winder with integrated guiding devices

### Unique features from Benninger

- Winds up rolls with optimum edge build-up
- Individual winding adjustments for different fabric styles
- Shell preparation system
- Safety curtain



# Winding systems

## Weighing and Wrapping Unit



Weighing and Wrapping unit CORD WRAP



Tire Cord rolls ready for dispatch

The precise weight of a dipped fabric roll is determined by the BELT WRAP weighing and wrapping unit which also wraps the roll in special films for protection from UV and humidity. The process control automatically produce the corresponding self-adhesive barcode label so that each individual roll can be identified for complete quality assessment.

### CORD WRAP weighing and wrapping unit

- Complete process data allocation for each individual roll via barcode
- Integrated online weighing
- Labels produced automatically via central process control
- Product and quality reliably identified via barcode
- Basic version for rolls up to 4 tons weight, up to 2000 mm in diameter and up to 2000 mm in width



Automatic generated barcode labels

### Unique features from Benninger:

- Complete process data allocation for roll via barcode
- Solutions for rolls with a weight up to 11 tons

# Process control CORD TEC

## CORD VISU-Process parameter visualization



Main screen process control

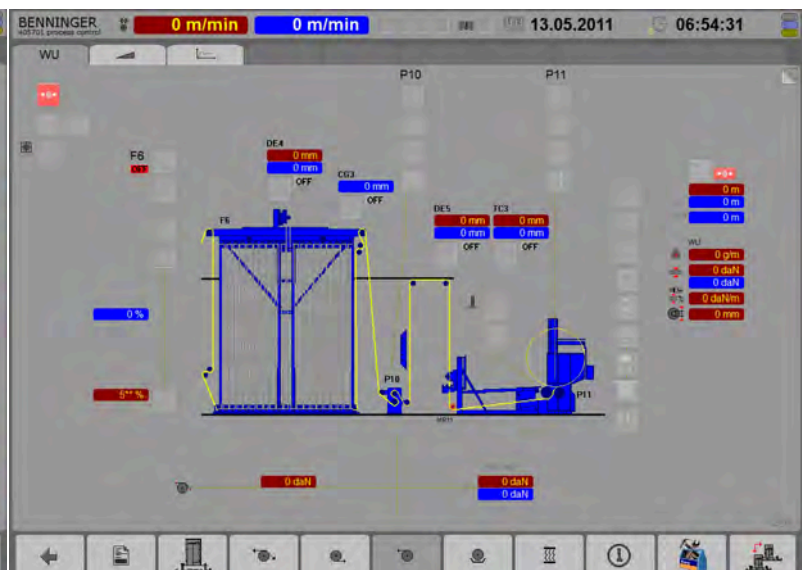

Detail screen accumulator- winder area

The CORD TEC process control has been under continuous development for more than 15 years. The engineers who are developing the system and the software also conduct the start up on the customer's premises. Of course bring in their own unique knowledge about the process control on site. During this time, more than 40 units have been delivered, some of which to all the well-known tire producers. The Benninger CORD TEC process control guarantees treatment reliability and reproducibility right up to the end product.

### CORD VISU process parameter visualisation

- Central control via clearly defined screens. Features of the comprehensive CORD VISU process control visualisation system include easy process data input and dynamic display of actual process values.
- Each graphic is adapted exactly to match your machine configuration. Process parameters and modifications can be entered directly into the relevant masks or tables. Incorrect values cannot be entered.
- Individual masks at various levels can be called up as required, even while the machine is in operation. Data retrieval and data printouts are available at any time.
- The unit is set up quickly and automatically for the next production run by calling up an existing "recipe".
- Effective production monitoring and immediate indication of the slightest parameter deviation on the relevant screen masks facilitate production control from start to finish. This makes it possible to implement corrections immediate if necessary, so that absolute safety in operation is guaranteed
- A 2nd HMI PC provides a high level of safety for operation and process through redundancy.
- Access to the various CORD TEC functions is achieved

### Features

- High-resolution colour monitor graphics for clear data and well defined images
- Full line view and partial view of the equipment
- Dynamic, real-time visualisation of all actual values
- Graphic tracing of splice positions
- Default language English, local languages are available
- CORD TEC access by password management
- USV system prevents data loss

### Unique features from Benninger

- 15 years experiences with tried-and-tested, CORD TEC process controller developed in-house
- 100% reproducible treatment conditions
- Software for diagnostics and troubleshooting
- Easy operation and minimum maintenance
- Step-by-step recipe engagement by the SPLICEMAN splice management system



# Process control CORD TEC

## CORD DATA-Process data storage and utilization

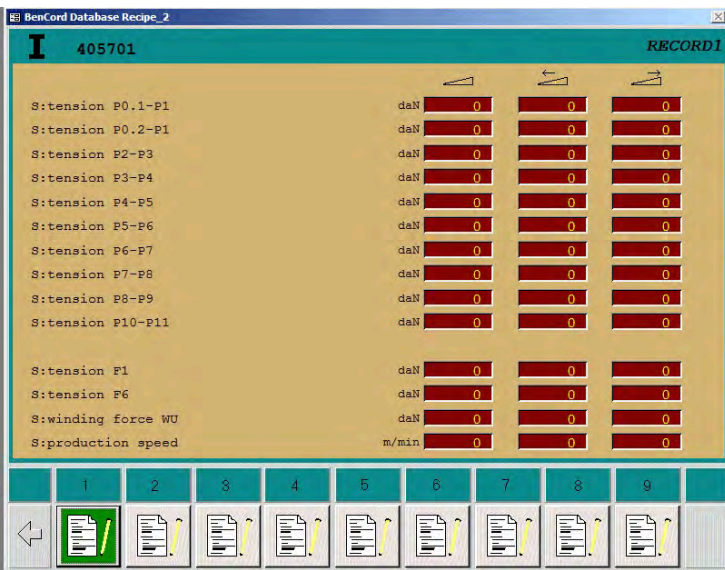

Main screen, treatment parameter input

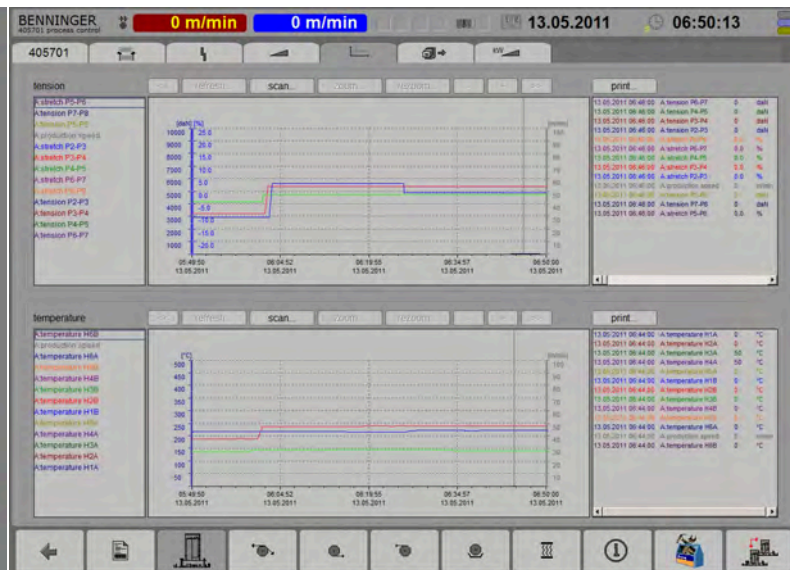

Diagrams of treatment course

Tire Cord manufacturers should be able to prove that their cord fabrics have left the company in perfect condition. Deviations should be defined exactly. This kind of quality verification is only possible when the production chain is controlled by a reliable process monitoring system. The Benninger CORD TEC process control with its CORD DATA system makes this possible

### CORD DATA process data storage and presentation.

- All the treatment parameters necessary for cord fabrics are stored as "recipes" on the system memory hard disc of the process control.
- During production runs, the CORD Data system records all the actual treatment data from the line in the system memory. Stored in Excel files and also in Access databases for universal use.
- Each production run is recorded in detail and each fabric roll receives a printed quality protocol, indicating the length and process data based on the recorded treatment data and production events. All the information can be retrieved at any time in graphical or text form.
- CORD DATA makes it possible to assign the production data for each product roll and batch. The treatment parameters for the line can be allocated to its position or length in a final product roll at any time.

### Features

- All treatment values handled and stored as recipes
- Dynamic modification of nominal values and recipes
- Maximum process reproducibility

### Benefits

- Long-term storage of all treatment data and events
- Process data and output prepared in all the usual formats
- Each product metre of the treated products is traceable.
- Process data output with function graphs associated with the product
- Predefined retrievable "alarm message list" (AML) and "chronological event list" (CEL).
- Easy connection to host computers via Internet access



Data base manager



Fabric roll protocol



Chronological event list



Screen for parameter input

# Process control CORD TEC

## SPLICEMAN-Splice management system



Splice management tools on the main screen

Safe and easy, convenient treatment changeover for different fabric styles is made possible by the unique SPLICEMAN splice management system. Efficiency is increased since the number of operator faults is reduced to a minimum and the amount of work required from personnel is therefore also reduced.

The system works on the principle of recording the splice position for each metre along the line.

### Features

- Indication of the actual splice positions while in operation.
- Graphical display showing different coloured indicator bars in an overview
- Pinpoint recording according to the number of running metres.
- All the treatment parameters are activated according to the splice position and applied to the subsequent treatment zones.
- E.g. tension or stretch, temperature, amount of circulation/exhaust air and the width of the guiding devices
- Activation can be automatic or manual.

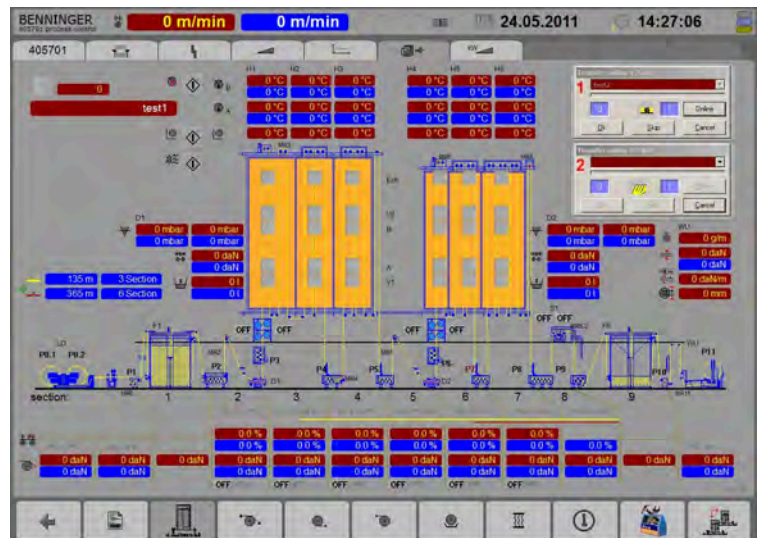

Splice management main screen

### Benefits

- Makes for safe operation due to the excellent overview of splice locations
- Treatment adapted precisely and easily to different cord fabric styles
- Product quality improved by exact reproducibility of parameter activation.



# Process control CORD TEC

## CORD DIAG-Diagnostic and help system

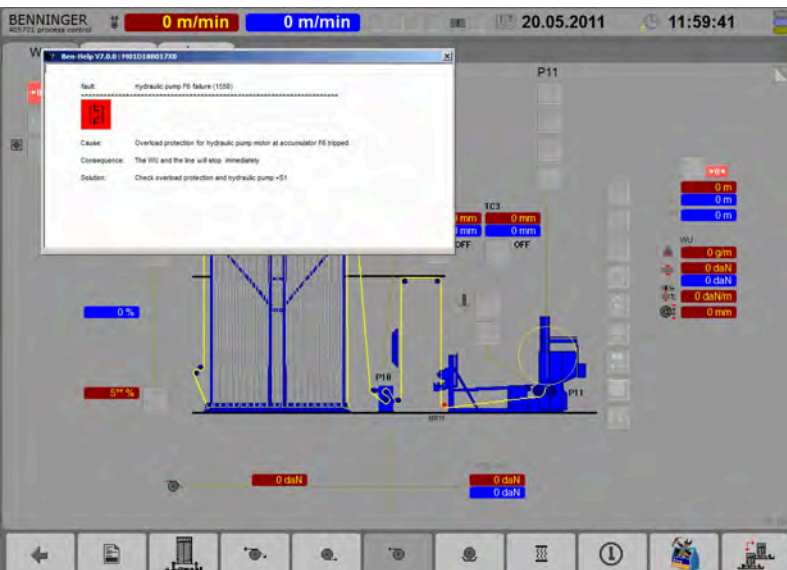

Trouble shooting with BEN HELP

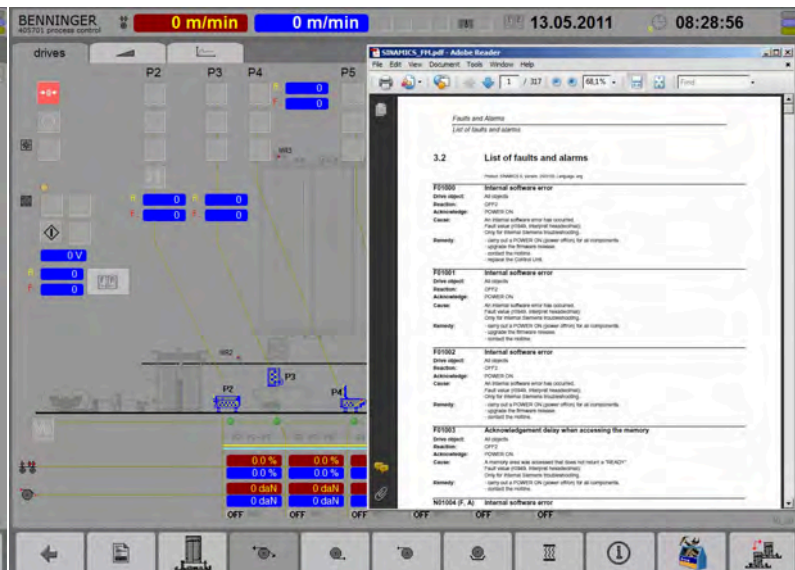

BEN HELP drive failure list

### CORD DIAG diagnostics and help system

In addition to the "alarm message list" and "chronological event list" already mentioned, implementation of the advanced help and diagnostic capabilities is achieved by:

- Faultfinder navigation which uses the fault message to locate the fault.
- Extended screens for fault diagnosis in order to provide a detailed diagnosis of the faulty part
- BEN HELP system for more information
- Extended help with fault description and warning codes for the inverter system

### Features

- HMI troubleshooting with diagnostics software and proposals for action
- Electronic diagnosis of drives and hardware
- Remote diagnostics, access to inverters and PLC and PCs, via Internet (VPN) or by phone (TELE LINK) if required
- Monitoring and storage of warnings and fault messages
- Alarm list with help function for troubleshooting



General faults screen

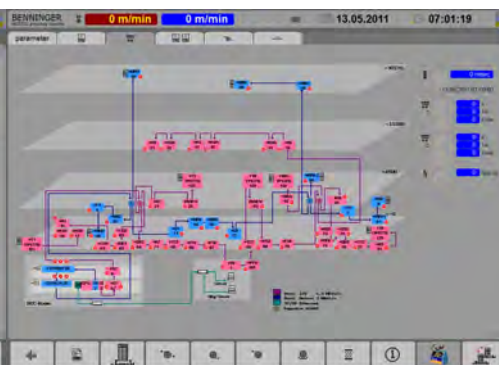

Bus faults

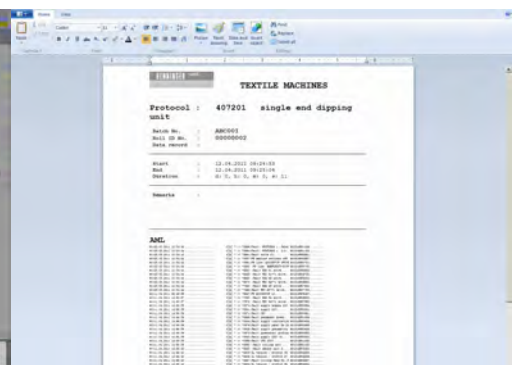

Alarm message protocol

# Process control CORD TEC

## Electrical hardware



Inverter (State-of-the-Art)



Operating desk

It is important that the electrical hardware components, as well as the unique CORD TEC software, are of the highest quality and reliability. Benninger ensures this level of quality by only using parts and systems from well-known and tried-and-tested brands such as “Siemens”. This is also in line with Benninger’s aim to ensure reliability and to provide service and spare parts availability, anywhere in the world. All components and modules are installed complete and tested with the associated software in our workshops before despatch. This ensures maximum safety and reliability and minimises installation work and start-up time on-site.

### Drives

- Benninger uses high quality, highly efficient, three phase asynchronous motors with high acceleration dynamics and fast braking response. These motors are controlled very precisely via digital speed indication and by using the latest generation of inverters.
- The power supply is via a DC power circuit which facilitates the regeneration of the electric energy from the pull-roll motors while in generating mode.

### PLC

- The central PLC processes all the instructions and settings from the HMI PC and uses these instructions to control all the line systems. The PLC ensures precise control of all parameters such as the let-off tension, line speed, stretch and tension by the pull rollers, dip pick-up via squeeze pressure and dewebbing effect, heating zones treatment and winder state.
- The PLC also handles the settings and monitoring of all other units such as guiding devices. The actual treatment data from the line are sent back to the HMI PC for visualisation and recording.

### Bus system

- The data transfer between all units and devices is via a bus system with a single cable. This simplified approach reduces the possibility of faults. It also facilitates quicker diagnosis and upgrading at reduced cost.

### Features

- High efficiency, maintenance free AC motors
- DC power supply circuit for energy regeneration
- 1 PLC device transferring all in-, output data, and processing and control of all line functions
- High-speed profi-bus system with non-central I/O structure
- Local operator panels with touch screen

### Benefits

- High reliability of all components
- Maintenance free AC drives
- Simple handling, easy electrical service
- Significant energy saving
- No adjustment work after replacing parts
- Easy fault-finding by a advanced diagnosis system
- Standard interface to host computer
- Easy diagnostic with TELE LINK

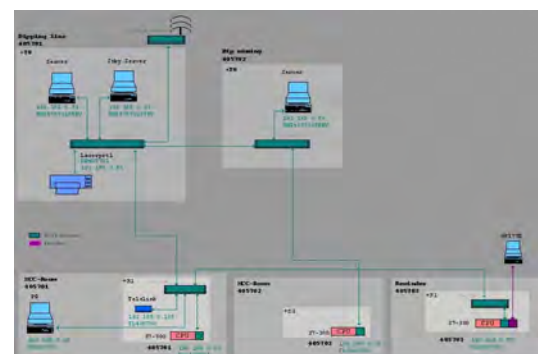

Network structure



# Dip solution preparation

## AUTO MIX-Automatic dip solution preparation unit

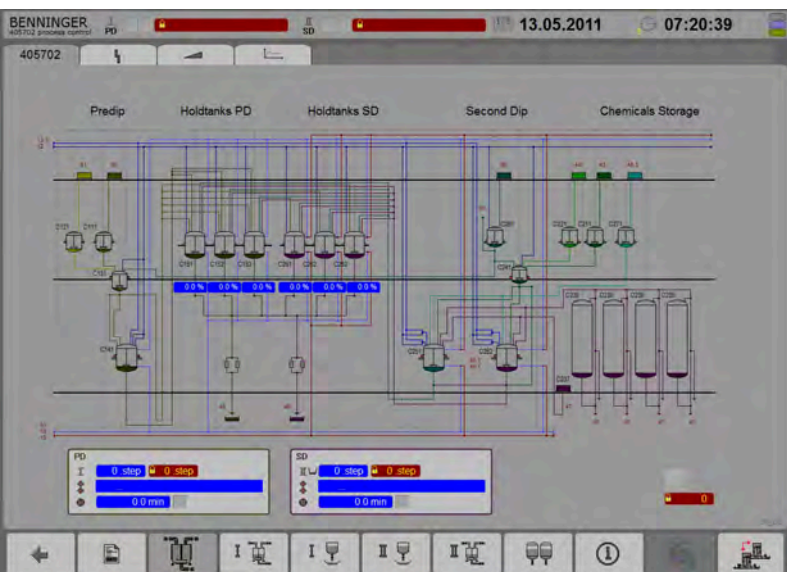

AUTO MIX main screen



Tanks and piping

The Benninger AUTO MIX dip solution preparation unit is by far the safest and most economical way to prepare dip solutions. These automatic preparation stations are unique since solution adjustment and recipe management is easy, and components dosing is precise and reproducible.

- The AUTO MIX system is designed to automate the preparation of pre-dip solution and RFL dip solution. It is possible to prepare a wide range of solution types.
- Menu-driven input of dip solution parameters - called recipes. Creation and modification of recipes is quick and easy, even with different tanks and pipe routes.
- All recipes and treatment data are recorded. The quality certificates for batches and various protocols can be retrieved at every time.
- The cleaning water for regular cleaning between different chemicals is calculated and used as part of the recipe
- Manual faults such as incorrect components and inaccuracies such as dosage errors are eliminated by automated preparation.
- The quality of the dip solution is therefore significantly improved. Even repeated solutions are all of the same quality and content.
- The system's ability to process recipes includes solution composition, choice of tanks, dosage and stand time for the chemicals.
- The AUTO MIX system can be monitored and accessed from a Benninger dipping unit
- Mechanical components such as valves, sensors, weighers, pumps and stirrers are selected and tested according to the chemicals used and the required precision.

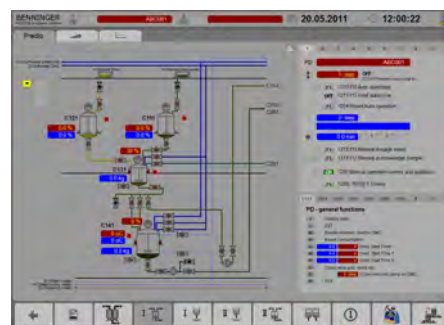

General operation

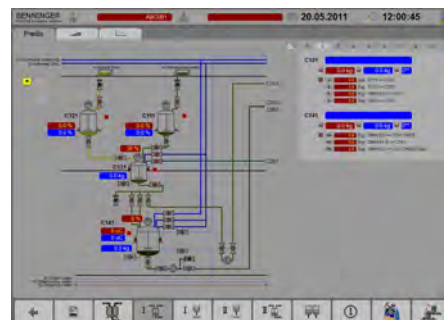

Parameter input for weighing tanks

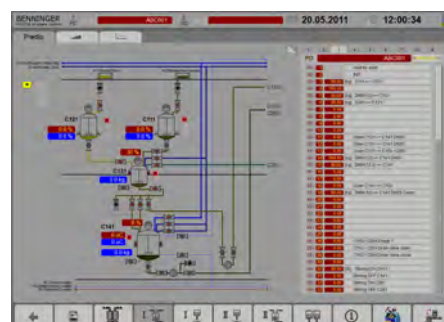

Recipe sequences (part)



# Dip solution preparation

## AUTO MIX-Automatic dip solution preparation unit



Dip solution hold tanks



Pumps and piping

### Features

- Flexible preparation/modification of various recipes
- Menu-driven input of preparation recipes
- Recipe integrated cleaning for tanks and piping
- Proven high quality hardware devices
- Total system size up to 25 tanks
- Capacity of tanks from 500 to 25,000 litres
- Precise preparation of single batches from 200 to 10,000 litres
- Monitored recipe tolerances 1 to 1.5% in compliance with applicable rules

### Benefits

- Improved dip solution quality
- Minimised chemical consumption.
- Significantly reduced waste
- Time saving due to preparation procedure
- 100% reproducible processing of dip recipes
- Almost no operating faults
- Quality certificate for the dip solutions

### Unique features from Benninger

- 100% reproducible processing of dip recipes
- Reduction of chemicals through tailored preparation
- Capture and logging of production data

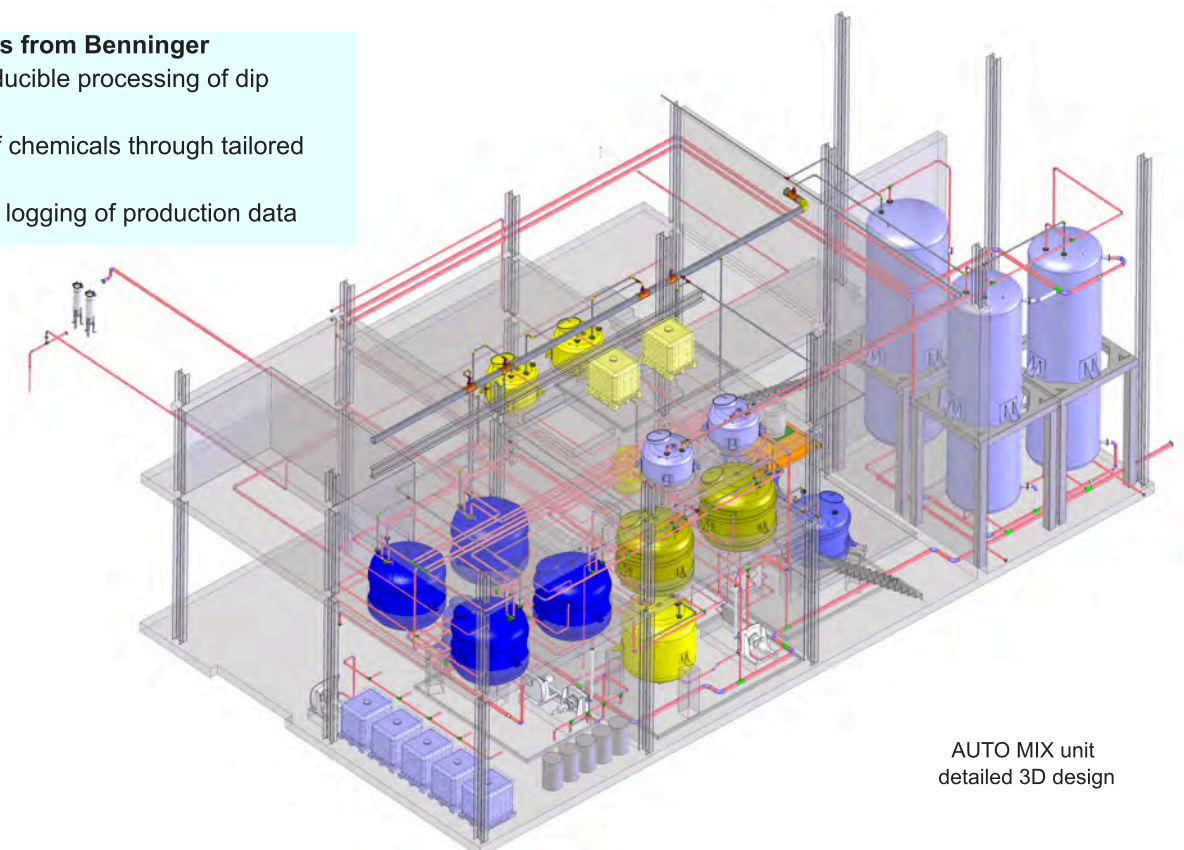

AUTO MIX unit  
detailed 3D design



# References

It would be a pleasure for us advising you

We would like to thank our customers:

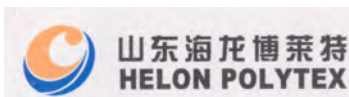

## Addresses

**BENNINGER**

### Benninger AG

9240 Uzwil, Switzerland  
T +41 71 955 85 85  
F +41 71 955 87 47  
info@benningergroup.com  
www.benningergroup.com

### Benninger Zell GmbH

Schopfheimerstrasse 89  
79669 Zell i.W., Germany  
T +49 7625 1 31 0  
F +49 7625 1 31 298  
tirecord@benningergroup.com

### Suzhou Benninger Küsters Machinery Co. Ltd

No. 11 Shi Yang Road,  
Xuguan Development Zone, Suzhou City,  
Jiangsu Province, 215151 P.R. China  
T 0086 512 8518 0380  
F 0086 512 8518 0381  
benchina@benningergroup.com

The data and illustration in the document correspond to the technical level at the time of printing and do not constitute a part of any offer.

The right to make alternations is reserved.

Copyright Benninger Zell GmbH, D, BW

September 2011, printed in Germany

**Imprint** Responsible for the content and the realisation: Benninger Zell GmbH, Zell i.W.;

Design: W. Schmidt; Pre-press and Print: Uehlin Print und Medien GmbH, 79650 Schopfheim (DE);

Please contact this address:

